

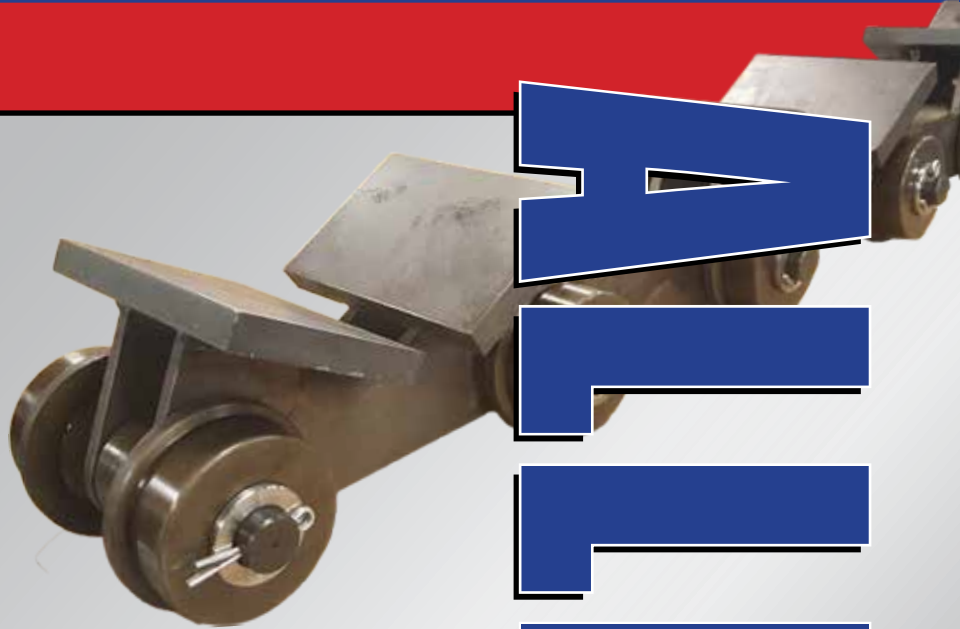

ISO 9001

Registered Quality System
Dixon, IL Plants Only



Chain and Sprockets for the Steel Mill Industry



ALLIED-LOCKE

★ Most Models Available in Carbon, Alloy and Stainless Steel ★

www.alliedlocke.com

Metal Processing Chain

Since 1965, Allied-Locke Industries, Inc. has designed and built chain and sprockets for nearly all industries that require chain products for drive units or material conveying. Our Products can be designed to meet or exceed original equipment standards.

We proudly offer American made options for all types of metal production facilities. We offer products to move coal, ores, billets, hot and cold formed product and any other chain and sprocket application found in these facilities.

Complete pan conveyor assemblies are available to transport sinter, scrap, coal, iron ore and other products used in metal production. We produce several pan conveyors and have the ability to make chain and pans to the specifications that you need.

Allied Locke Industries is equipped with engineering support, knowledgeable customer service staff, an excellent quality control process throughout manufacturing and with full metallurgic testing capabilities to make products that meet or exceed those of our competitors. Our manufacturing, heat treatment and fabrication can be completed under one roof. Additionally, we offer features such as custom outboard roller assemblies, attachments to match current configurations and hard chrome plating for extended wear life.



V-Top Options



Block and Bar Chain



Billet Mover Chain



Top Roller Material Handling Chain

Draw Bench Chain

Allied-Locke produces industry standard draw bench chain. Chain sizes are available in pitches from 1.63- 12.00". Split pitch (inner and outer links have different pitches) chain and sprockets are also available.

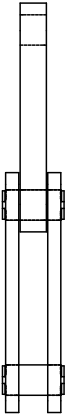

Style 1
2X1 Lacing

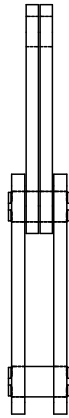

Style 2
2X2 Lacing

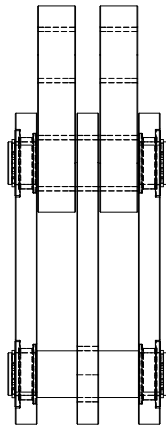

Style 3
3X2 Lacing

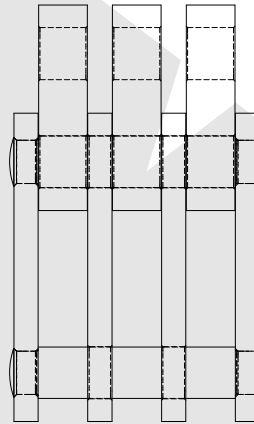

Style 4
4X3 Lacing

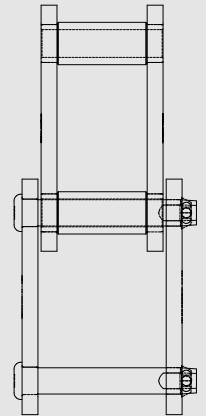

Style 5
Bushed
Steel



In addition to these common draw bench chains, custom, direct replacement chain and sprockets are available for your application.

Connectors are available in riveted, cottered, snap ring, plug weld and other options to suit your needs.

Hard chrome plating options are available for improved wear life.



Straight Sidebar Roller Chain

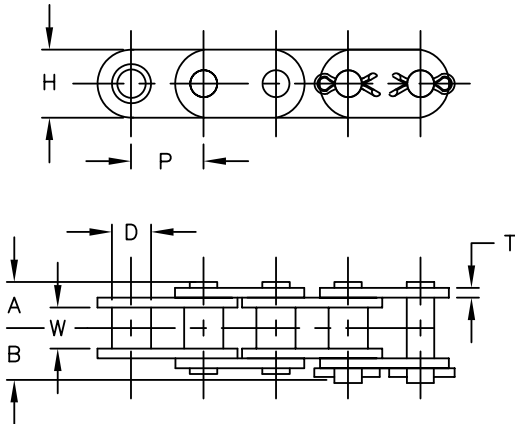
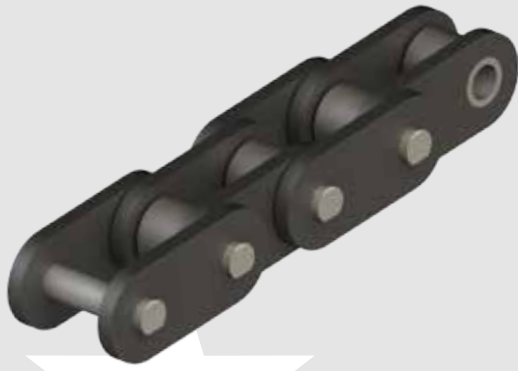

Straight Sidebar, Conveyor Series Roller Chain										
Chain Number	Pitch	Roller		Pin			Link Plate		AVG Ultimate Strength (Lbs)	AVG Weight Lbs/Ft
	P	W	D	A	B	E	H	T		
C60	.750	.500	.469	.497	.551	.234	.712	.093	9,270	.97
C80	1.000	.625	.625	.645	.724	.312	.950	.125	16,540	1.71
C100	1.250	.750	.750	.789	.941	.375	1.188	.157	25,360	2.65
C120	1.500	1.000	.875	.983	1.219	.437	1.425	.189	32,640	3.79
C140	1.750	1.000	1.000	1.066	1.259	.500	1.663	.219	45,210	4.96
C160	2.000	1.250	1.125	1.282	1.469	.563	1.901	.255	57,780	6.32
C12B	.750	.460	.475	.444	.526	.225	.615	.073	7,200	.86
C16B	1.000	.670	.625	.713	.776	.326	1.002	.125 O* .157 I*	17,100	1.94
C20B	1.250	.770	.750	.791	.791	.401	1.142	.125 O* .176 I*	23,100	2.59
C24B	1.500	1.000	1.000	1.066	1.066	.576	1.493	.189 O* .236 I*	39,600	4.93
C28B	1.750	1.220	1.100	1.297	1.297	.626	1.834	.236 O* .287 I*	53,300	6.59
C32B	2.000	1.220	1.150	1.305	1.305	.701	1.794	.236 O* .276 I*	63,700	6.84

* "O" = Outer Sidebar, "I" = Inner Sidebar

- Typically supplied in riveted style chain.
- Chrome pins are also available for extended wear life.
- In addition to the sizes listed above, Allied-Locke offers a complete range of standard series ANSI and metric roller chains- Single strand and multiple strand chains (through -8 strand).
- XDO[®] roller chain in ANSI sizes is available for the best performance roller chain on the market.

Many types of attachments are available for our roller chain. Material handling top pads are common for our customers in the metal production field. Please call Allied-Locke today and we will work to identify, quote and manufacture the chain and attachments that you require.

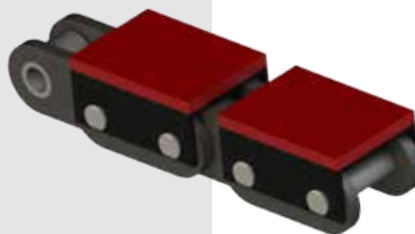

Pan Conveyors, Billet Movers & Reclaim Options



Pan conveyors can be customized to exact customer specifications.



Custom outboard roller assemblies can be designed to increase overall life of your conveyor systems.



Attachments and Anti Back Flex Features Available



Custom Material Handling Options



Saddle Top chain with Outboard Rollers



Dual Strand Reclaim Conveyor

High Sidebar Options

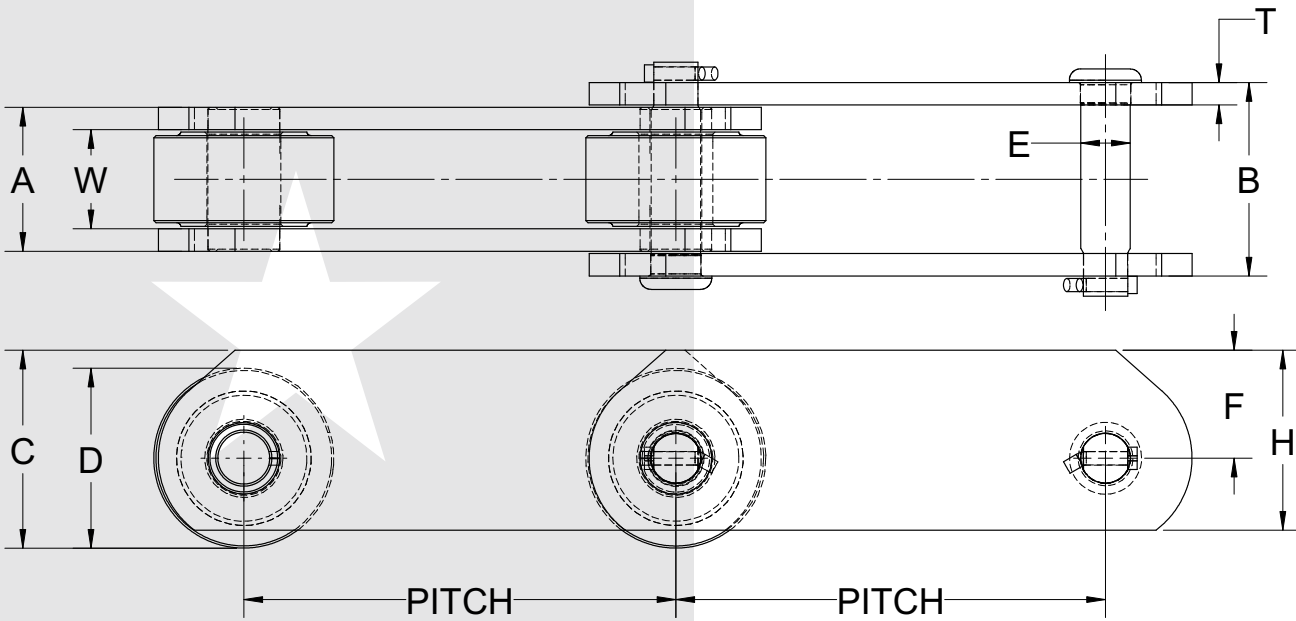

CHAIN	PITCH	PIN			ROLLER		SIDEBAR				AVG. ULT. STRENGTH	WORKING LOAD	WEIGHT PER FT.
		E	D	W	A	B	T	H	C	F			
MSR1317 *	3.000	0.44	1.50	1.00	1.38	1.78	0.19	1.50	1.69	0.94	13,000 LBS	2,100 LBS	4.5 LBS
MSR2439	4.000	0.44	1.25	0.63	1.13	1.66	0.25	1.50	1.59	0.97	24,200 LBS	1,700 LBS	3.9 LBS
CC5	6.000	0.69	2.50	1.38	2.00	2.69	0.31	2.50	2.75	1.50	50,000 LBS	4,800 LBS	11.0 LBS

CC5 Chain is typically supplied with cottered pins throughout the chain.

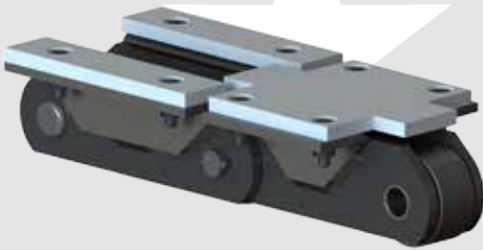

Top Pad Attachments

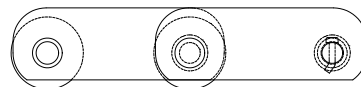

*MSR1317 Profile



Hex Hole Attachments

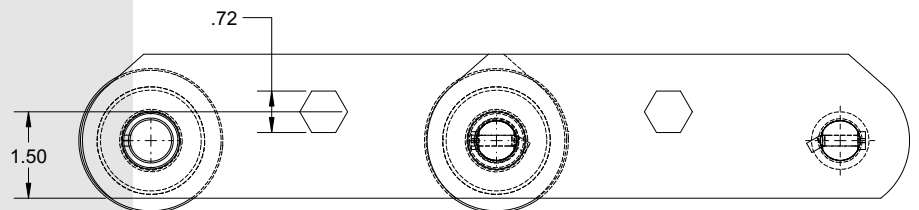

Top roller available every 12" or 24"

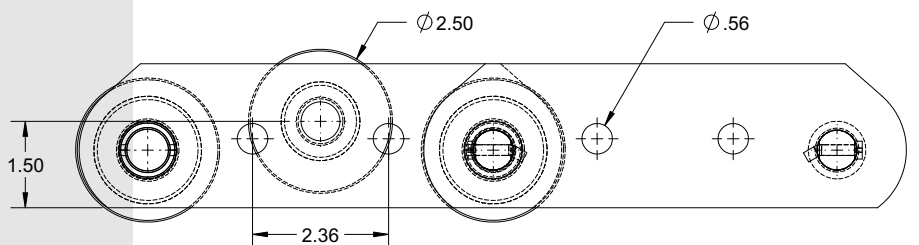

Draw Bench and Machinery Sprockets

Allied-Locke offers sprockets for the chain that we produce. From simple A, B and C-Hub options, to keyless locking devices, taper lock connectors, split and segmented sprockets, we can produce whatever options our customers need.



A-Plate

B-Hub

C-Hub



Segmental sprockets are available for ease of installation. The segments are replaced one at a time, saving time, money and effort.



Custom fabricated sprockets can be made with replaceable teeth, lightening holes, stress reduction rims and many other options.



Allied-Locke produces custom sprockets to match our variety in draw bench chain. Our precision machining capabilities are unmatched in the industry.



ALLIED-LOCKE INDUSTRIES, INC.

800.435.7752 - TOLL FREE PHONE

800.462.3130 - FAX

info@alliedlocke.com

www.alliedlocke.com

ISO 9001

Registered Quality System

Dixon, IL Plants Only



Corporate Office and Manufacturing Plant #1

1088 Corregidor Road • P.O. Box 509

Dixon, IL 61021



Manufacturing Plant #2

1020 Subic Road

Dixon, IL 61021



Manufacturing Plant #3

226 Industrial Circle

Union, MS 39305

Member of:



www.alliedlocke.com

CS191 Rev. 1/18